

## Aufmaßblatt: "Schiebetüren in der Wand laufend"

### ► Vertikalschnitt

Schiebetür ohne Blenden

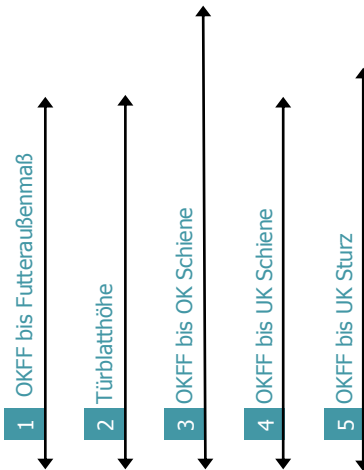
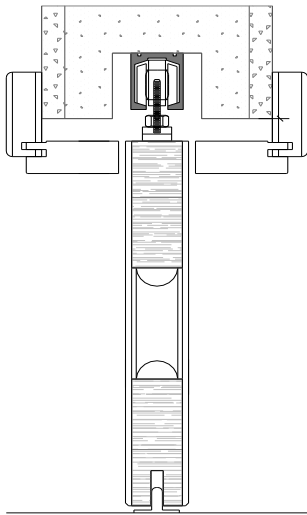

Schiebetür mit Blenden

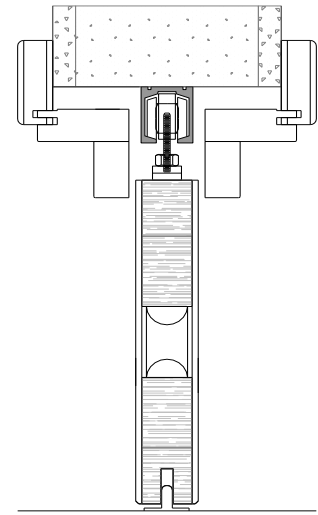

1 OKFF bis Futteraußenmaß-Höhe  mm    2 Türblatthöhe  mm  
 3 OKFF bis OK Schiene  mm    4 OKFF bis UK Schiene  mm    5 OKFF bis UK Sturz  mm

### ► Horizontalschnitt

**DIN rechts**  
von schmaler Futterseite aus gesehen nach rechts öffnend

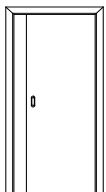

Wandstärke, gesamt  mm

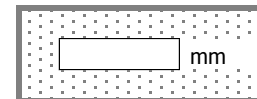
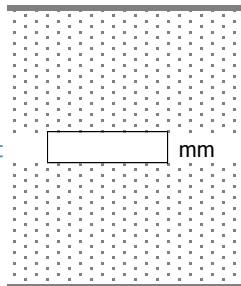

1. Wandstärke  mm

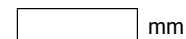

Mauertasche  mm

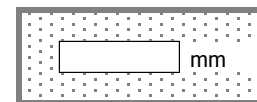

2. Wandstärke  mm

**DIN links**  
von schmaler Futterseite aus gesehen nach links öffnend

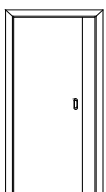

1. Wandstärke  mm

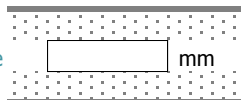

Mauertasche  mm

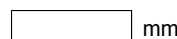

2. Wandstärke  mm

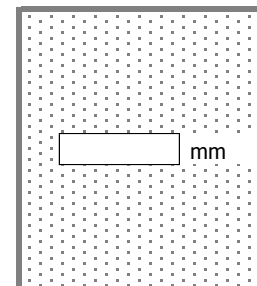

Wandstärke, gesamt  mm

**2-flügelig**

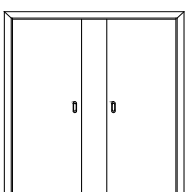

1. Wandstärke  mm

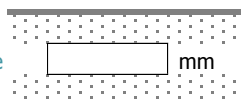

Mauertasche  mm

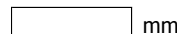

2. Wandstärke  mm

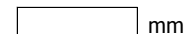
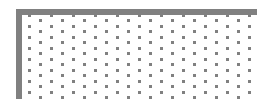

Wandstärke, gesamt  mm